

Datasheet

Product type: **Tube damper horizontal**
 Product ID: 155010
 Product name: RVK H 315

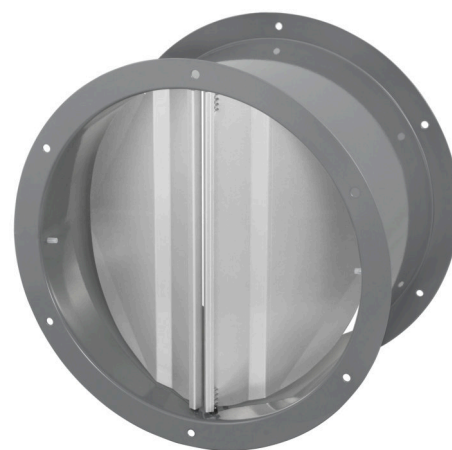
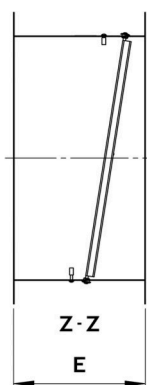
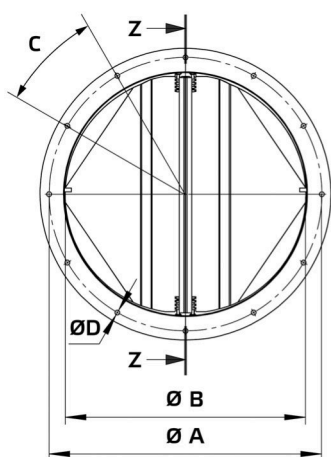

A	mm	355
B	mm	315
C		10 x 36°
D	mm	8
E	mm	8
Weight	kg	3.2

- Automatic shutter
- Sheet steel, powder-coated
- Flange mounting
- For horizontal installation
- Suitable for outdoor installation

Use:

- AL 315 D4 01
- AL 315 D2 01
- AL 315 EC 01