

# Datasheet

Product type: **Round inlet spigot**  
Product ID: 154303  
Product name: RAS 450 F4

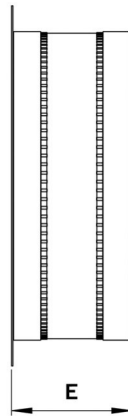
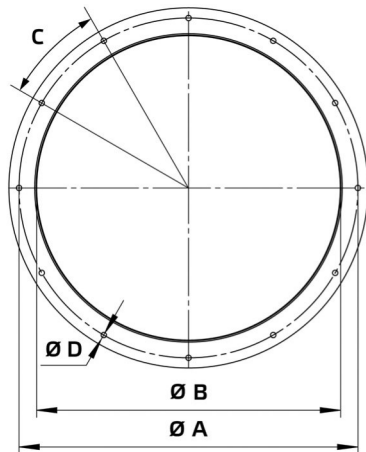

A	mm	500
B	mm	450
C		12 x 30°
D	mm	8
E	mm	105 ... 175
Weight	kg	4.5

- Flexible connection
- Continuous temperature 75°C
- Sheet steel, galvanized
- Silicone band
- Temperature class according to DIN EN 12101-3 F400 (400°C/120min)

## Use:

- AL 450 D4 F4 01
- AL 450 D2 F4 01